

# Branding outdoor



Julien Igosse  
info@dynagraph.be  
+32 479 11 17 27

## Welcome totem

A: 3 sides standing totem: 2,20 x 0,5 m



eventlounge.be

info@eventlounge.be  
+32 (0)2 726 55 26

Bd. Général Wahislaan  
16F, 1030 Brussels

# Branding outdoor



Julien Igosse  
info@dynagraph.be  
+32 479 11 17 27

## Printed vinyle on windows - Left side

C1	0,98 x 1,15 m
C2 - C3 - C4 - C5	1,78 x 1,15m
C6	0,77 x 2,17 m
C7 - C8	1,78 x 0,92 m
C9	1,78 x 0,45m
C10	1,78 x 0,52 m
C11 - C12	1,50 x 2,15 m



## Printed vinyle on windows - Right side

D1 - D2 - D3 - D4	1,78 x 1,15 m
D5, 6	1,78 x 0,92 m
D7	1,78 x 0,45 m
D8	1,78 x 0,52
D9 - D10	1,55 x 2,17 m



eventlounge.be

info@eventlounge.be  
+32 (0)2 726 55 26

Bd. Général Wahislaan  
16F, 1030 Brussels

# Branding outdoor



Julien Igosse  
info@dynagraph.be  
+32 479 11 17 27

## Beach flags

E, F, G: 3 options

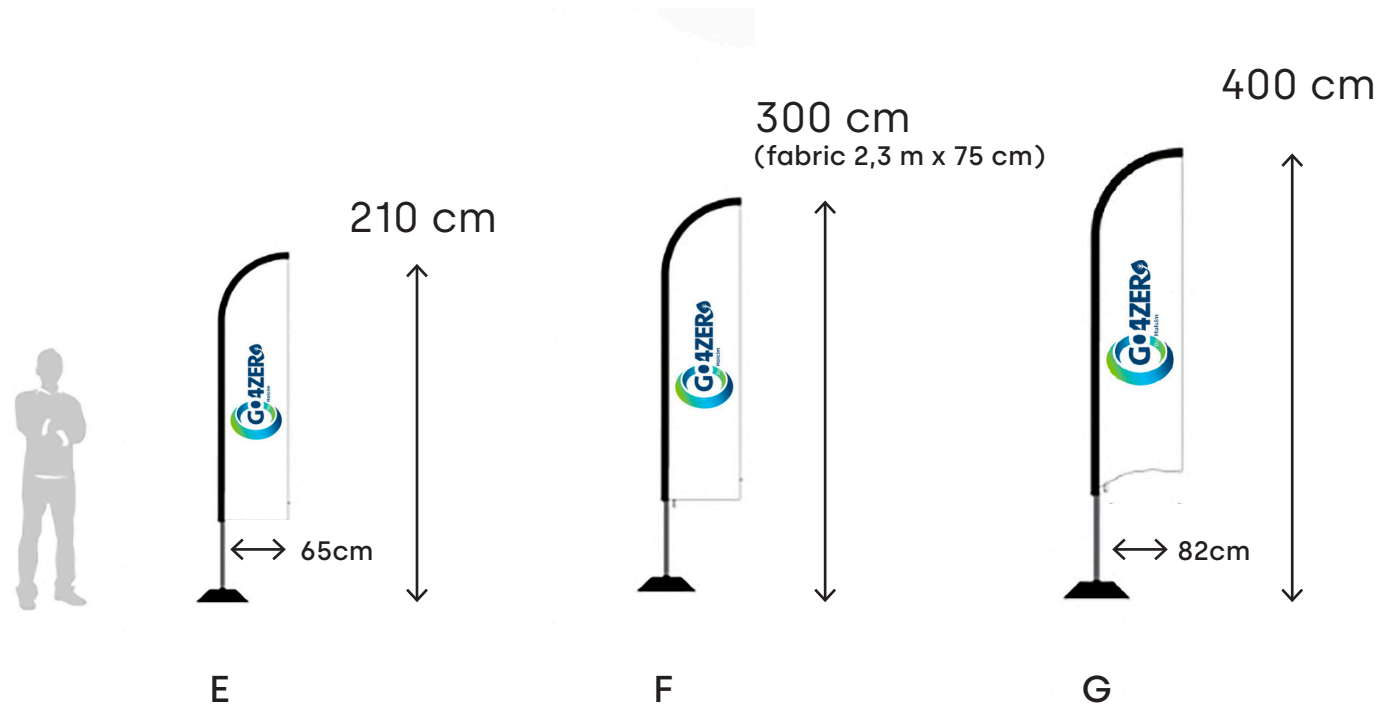

eventlounge.be

info@eventlounge.be  
+32 (0)2 726 55 26

Bd. Général Wahislaan  
16F, 1030 Brussels

# Branding lobby - entrance area



Julien Igosse  
info@dynagraph.be  
+32 479 11 17 27

## Welcome desk

H: 4,08 x 1,15 m

I: 2,40 x 1,15 m + 0,68 x 1,15 m

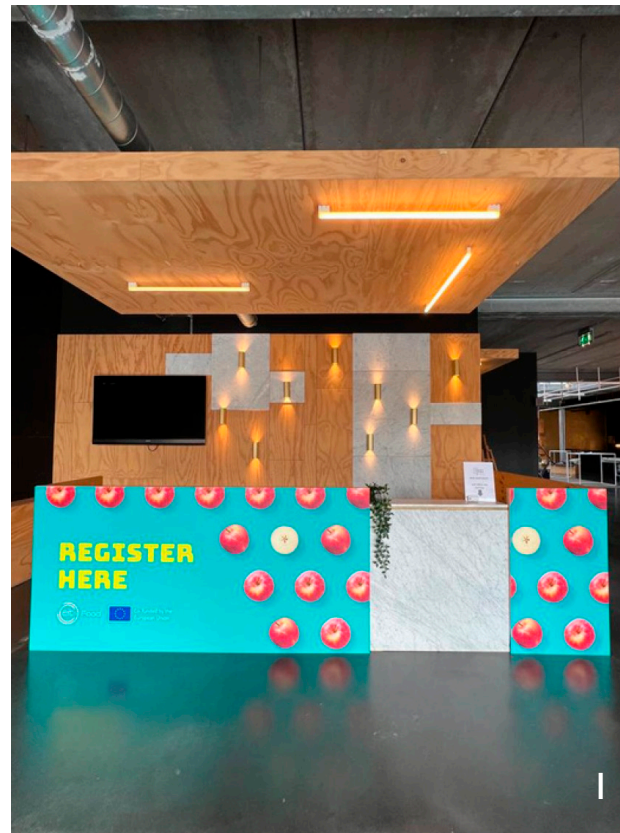
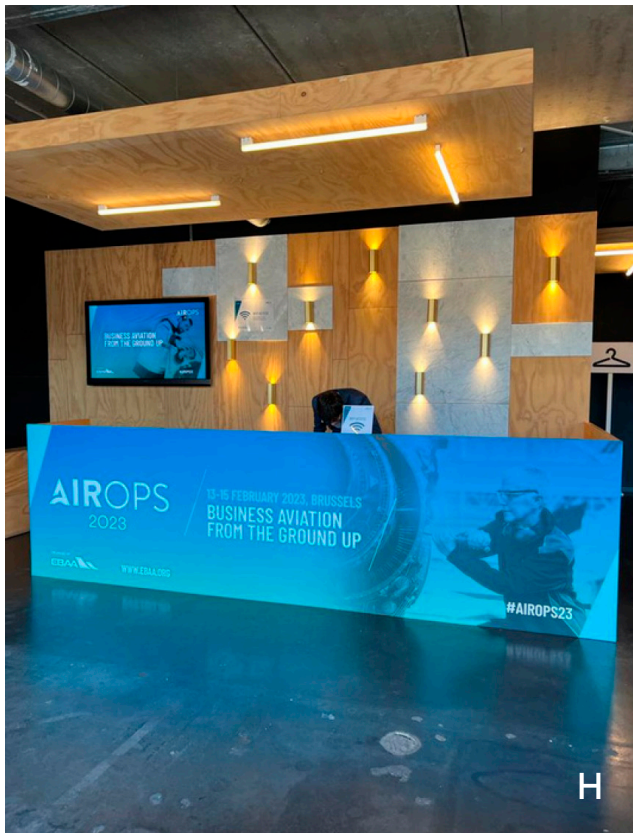

eventlounge.be

info@eventlounge.be  
+32 (0)2 726 55 26

Bd. Général Wahislaan  
16F, 1030 Brussels

# Branding lobby - entrance area



Julien Igosse  
info@dynagraph.be  
+32 479 11 17 27

## Directional signage

J: Lettering

K: Lines on the floor 6 cm x 20 m

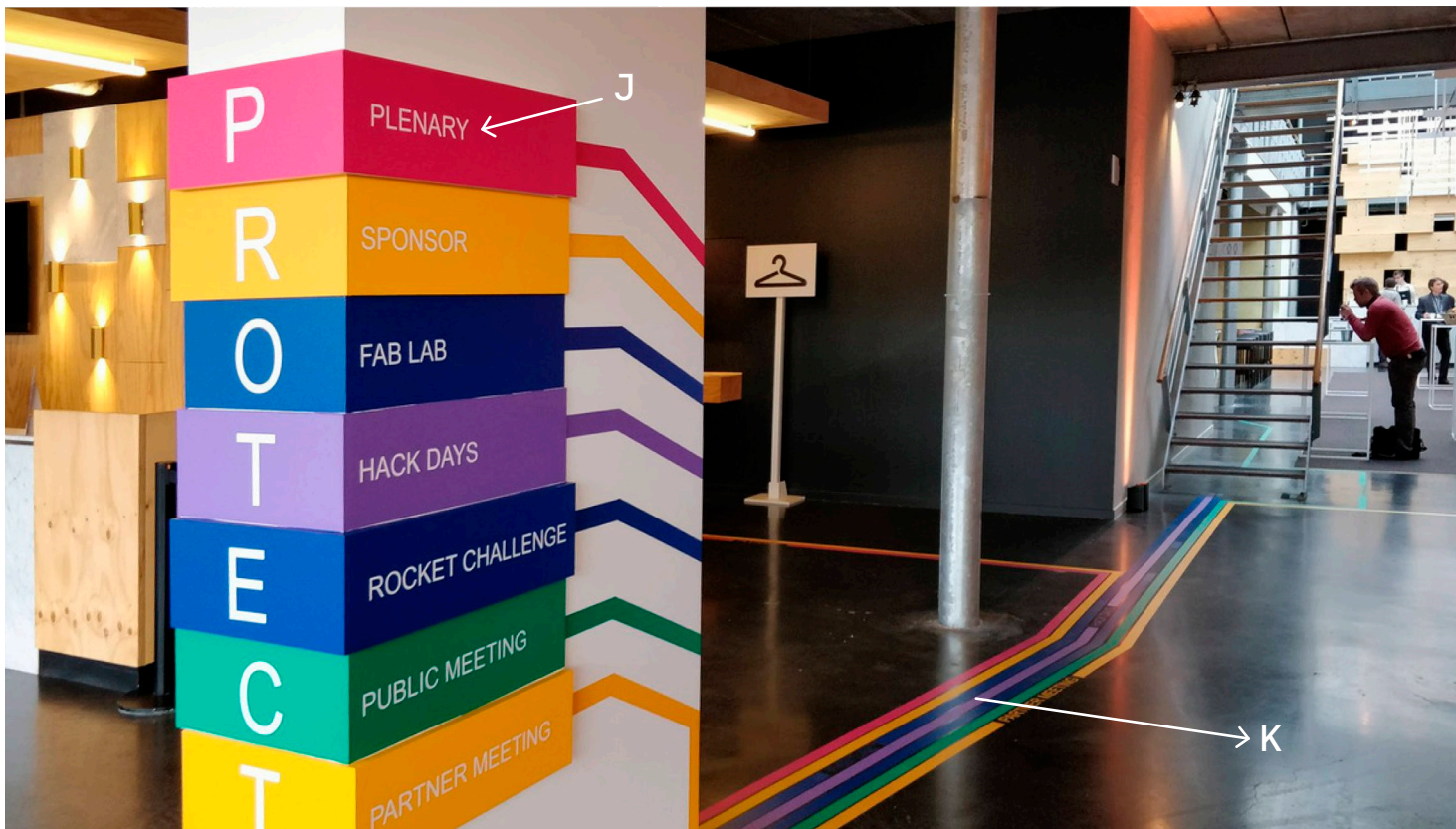

eventlounge.be

info@eventlounge.be  
+32 (0)2 726 55 26

Bd. Général Wahislaan  
16F, 1030 Brussels

# Branding lobby - entrance area



Julien Igosse  
info@dynagraph.be  
+32 479 11 17 27

## Wooden blocks wall

Blocks L3 - L5 - L9 - L10 - L11 - L13	1,80 x 0,39 m
Blocks L1 - L2 - L4 - L6 - L7 - L8 - L12	2,40 x 0,39 m

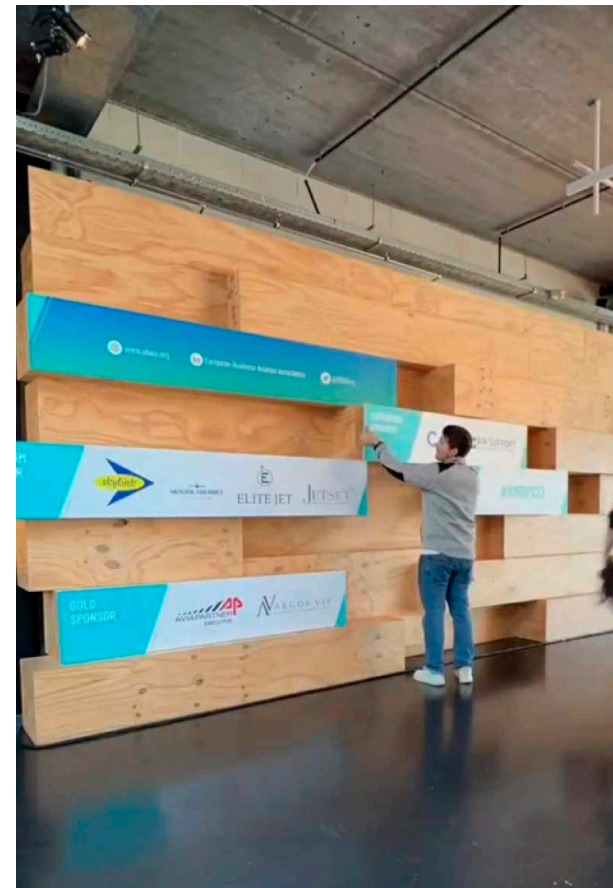
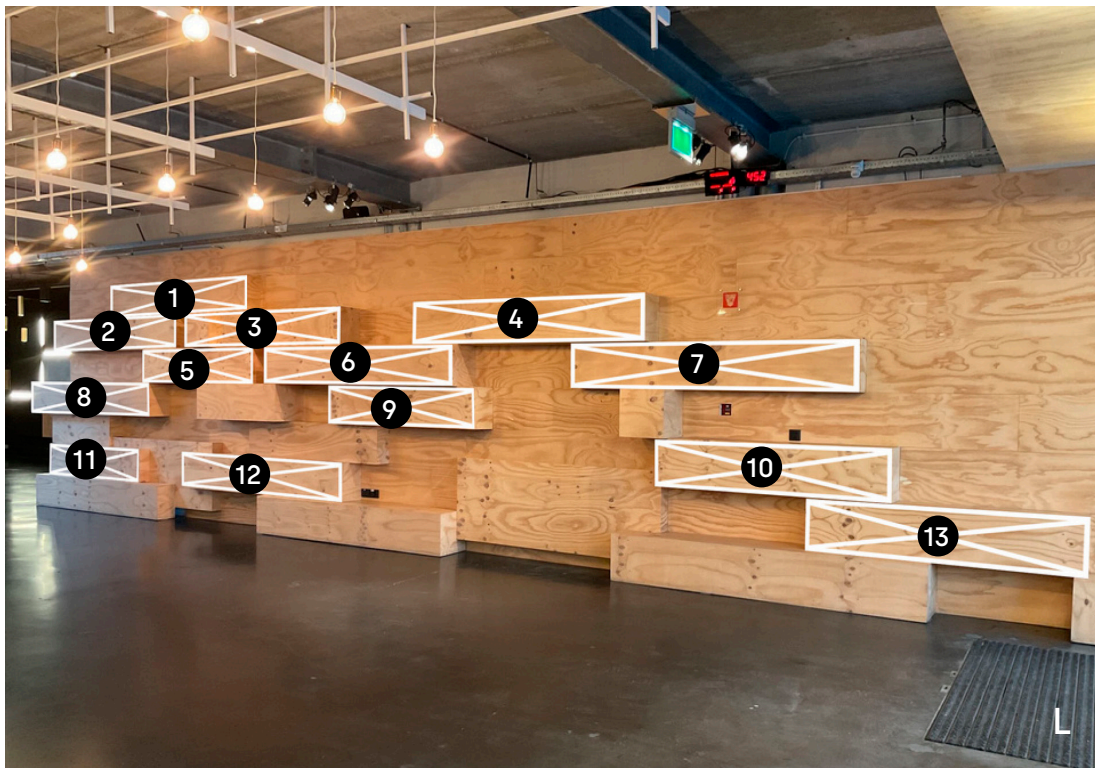

eventlounge.be

info@eventlounge.be  
+32 (0)2 726 55 26

Bd. Général Wahislaan  
16F, 1030 Brussels

# Branding lobby - bar area



Julien Igosse  
info@dynagraph.be  
+32 479 11 17 27

## Lobby's ceiling

M: Hanging printed fabric 3 x 1 m



## Illuminated wall

N: 1,13 x 0,80 m



eventlounge.be

info@eventlounge.be  
+32 (0)2 726 55 26

Bd. Général Wahislaan  
16F, 1030 Brussels

# Branding lobby - bar area

 Julien Igosse  
 info@dynagraph.be  
 +32 479 11 17 27

## Wooden blocks wall

Block O5	2,43 x 0,39 m
Blocks O4 - O7 - O8 - O10	1,80 x 0,39 m
Blocks O1 - O2 - O3 - O6 - O9	2,40 x 0,39 m

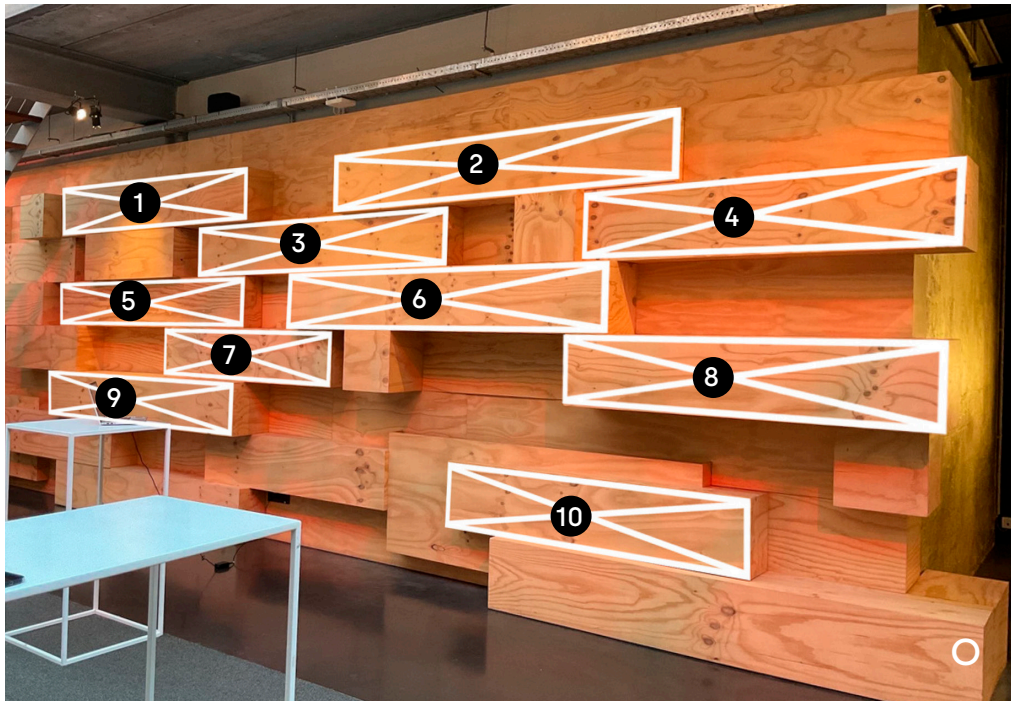

P: Block 1,80 x 0,39 m - Block 2,40 x 0,39 m  
 Q: 3,02 x 1,13 m



eventlounge.be

info@eventlounge.be  
 +32 (0)2 726 55 26

Bd. Général Wahislaan  
 16F, 1030 Brussels



# Branding lobby - bar area



Julien Igosse  
info@dynagraph.be  
+32 479 11 17 27

## Illuminated wall

R: 16x rectangle 1,16 x 0,60 m

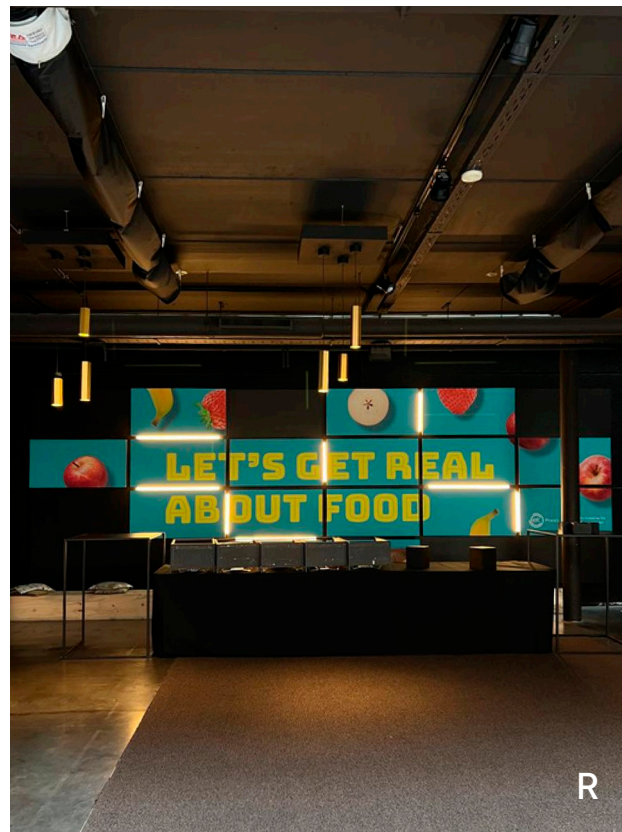

eventlounge.be

info@eventlounge.be  
+32 (0)2 726 55 26

Bd. Général Wahislaan  
16F, 1030 Brussels

# Branding studio



Julien Igosse  
info@dynagraph.be  
+32 479 11 17 27

## Illuminated wall

S: Hanging printed fabric 7 x 3 m



eventlounge.be

info@eventlounge.be  
+32 (0)2 726 55 26

Bd. Général Wahislaan  
16F, 1030 Brussels

# Branding conference rooms



Julien Igosse  
info@dynagraph.be  
+32 479 11 17 27

## Reading desk

T: 1x ground floor 50 x 125 cm

U: 2x 1st floor 52,5 x 118 cm

## Roll-up

V: 85 / 100 x 200 cm

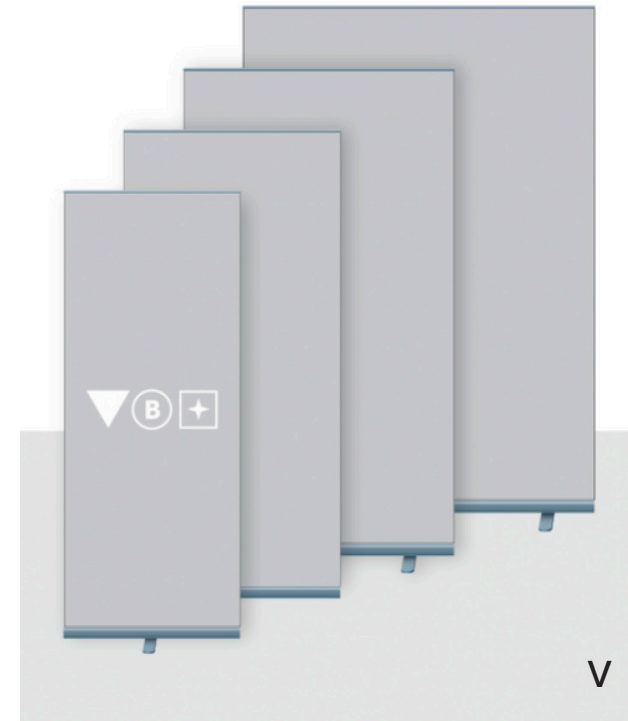

eventlounge.be

info@eventlounge.be  
+32 (0)2 726 55 26

Bd. Général Wahislaan  
16F, 1030 Brussels